

ILLUSTRATED PARTS LIST

MODEL NUMBER LM 2150SM

PRODUCT NUMBER 961 11 00-24

MFG. ID. NUMBER 96111002408

JONSERED ROTARY LAWN MOWER - MODEL NO. LM 2150SM (96111002408) PRODUCT NO. 961 11 00-24

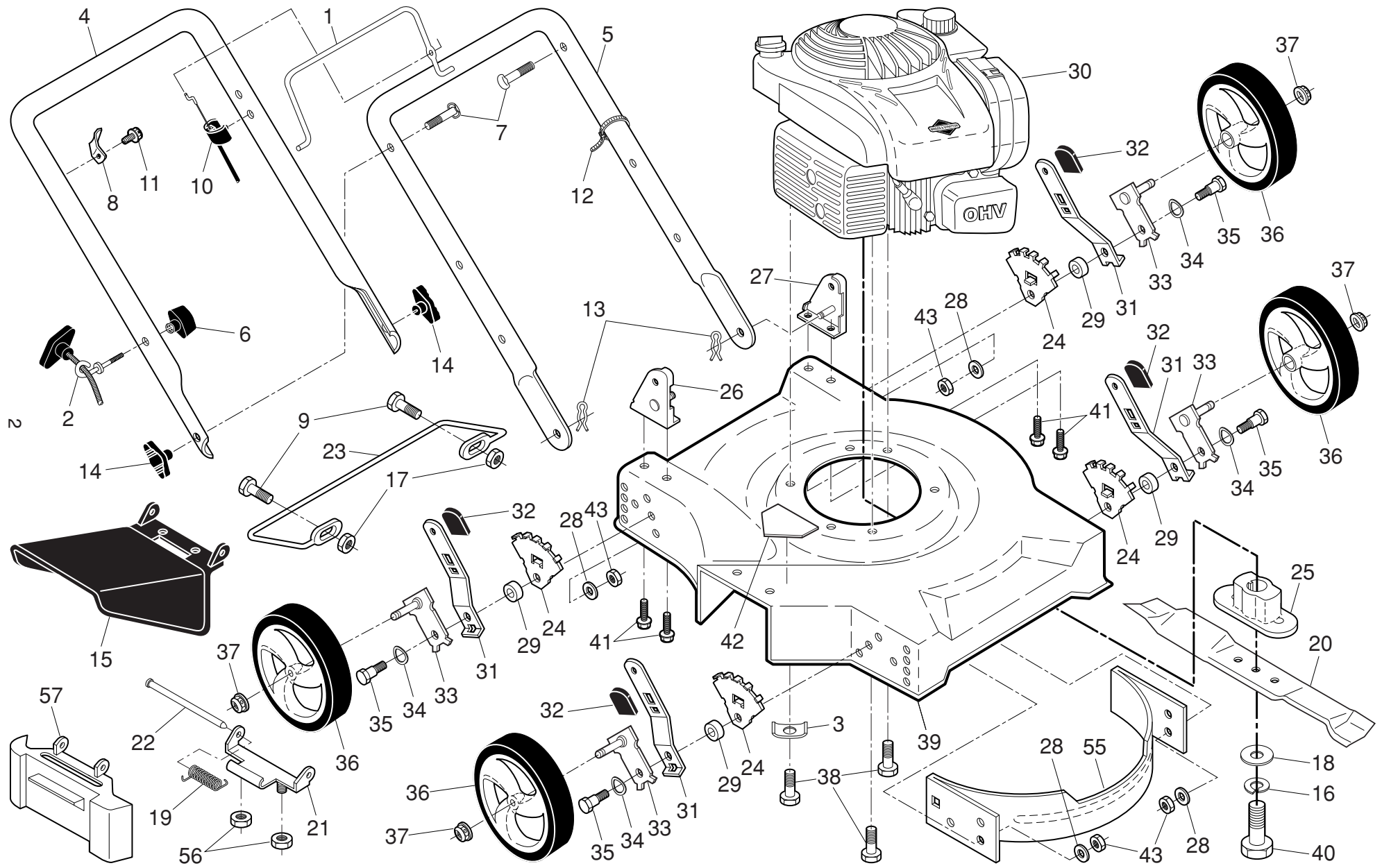

JONSERED ROTARY LAWN MOWER - MODEL NO. LM 2150SM (96111002408) PRODUCT NO. 961 11 00-24

KEY NO.	PART NO.	DESCRIPTION	KEY NO.	PART NO.	DESCRIPTION
1	532 19 60-25	Control Bar	27	532 17 09-77	Handle Bracket Assembly, LH
2	581 90 21-01	Rope Guide	28	532 06 15-37	Washer
3	532 12 50-78	Engine Washer	29	532 40 16-29	Spacer
4	532 44 82-63	Upper Handle	30	- - -	Engine, Briggs & Stratton, Model Number 8P502-0014-H1 (order parts from engine manufacturer)
5	532 43 45-14	Lower Handle	31	532 40 64-28	Selector Spring
6	581 91 26-01	T-Knob	32	532 08 78-77	Selector Knob
7	532 19 15-74	Handle Bolt 5/16-18 x 1-3/4	33	532 40 78-71	Axle Arm Assembly
8	532 43 00-34	Up-Stop Bracket	34	532 40 16-30	Washer, Curved, Cylindrical
9	871 19 10-12	Screw	35	532 40 16-38	Shoulder Bolt
10	532 44 09-34	Engine Zone Control Cable	36	532 19 70-25	Wheel & Tire Assembly
11	532 17 88-48	Screw, Hex Washer Head #10-16 x 5/8	37	532 40 91-48	Nut, Hex
12	532 06 64-26	Wire Tie	38	532 15 04-06	Hex Head Thread Rolling Screw 3/8-16 x 1-1/8
13	532 05 17-93	Hairpin Cotter	39	581 70 83-48	Kit, Lawn Mower Housing
14	532 19 19-38	Wing Nut, Steel	40	532 85 10-84	Hex Head Screw 3/8-24 x 1-3/8 Grade 8
15	532 43 20-40	Discharge Guard	41	532 14 97-41	Thread Cutting Screw 5/16-18 x 3/4
16	532 85 02-63	Helical Lockwasher 3/8	42	532 18 21-66	Danger Decal
17	532 06 91-80	Nut, Hex	43	873 80 05-00	Locknut, Hex 5/16-18
18	532 85 10-74	Hardened Washer	55	532 14 15-19	Front Baffle
19	532 41 18-32	Spring, Torsion	56	873 80 04-00	Nut, Hex
20	532 14 51-06	Blade, 20"	57	532 41 24-00	Mulcher Plug
21	532 08 86-02	Bracket, Torsion	--	532 18 21-91	Decal, Warning (not shown)
22	532 15 02-15	Rod, Torsion	--	532 14 15-20	Rear Baffle (not shown)
23	532 43 19-95	Footguard	--	115 62 50-20	Operator's Manual, European
24	532 41 05-94	Wheel Adjusting Bracket	--	115 62 50-10	Operator's Manual, Scandinavian
25	581 54 79-01	Blade Adapter	--	115 62 51-50	Operator's Manual, East Bloc
26	532 17 09-75	Handle Bracket Assembly, RH	--	115 62 50-40	Operator's Manual, Baltic

3

NOTE: All component dimensions given in U.S. inches. 1 inch = 25.4 mm. **IMPORTANT:** Use only Original Equipment Manufacturer (O.E.M.) replacement parts. Failure to do so could be hazardous, damage your lawn mower and void your warranty.